













## Dati Tecnici - Specifications

											
	cond	comp. W	ABS. W	Fuse	Kwh/100Kg	I / h	kg	Lbs	kg	Lbs	Ton CO2 equiv.
M402 A		4360	2100	16	13.1	19.0	88	194	106	234	4,94
M402 W		4360	1900	16	10.6	210	83	183	101	223	2,55

## 24h Produzione Ghiaccio - Ice Production

### Raffreddamento ad aria - Air Cooled Unit

Temp. aria Air Temp.	Temp. acqua / Water Temp.			
	32°	21°	15°	10°
°C	32°	21°	15°	10°
°F	90°	70°	60°	50°
10°	<b>360</b>	<b>395</b>	<b>420</b>	<b>430</b>
50°	794	871	926	948
21°	<b>340</b>	<b>370</b>	<b>390</b>	<b>400</b>
70°	750	816	860	882
32°	<b>280</b>	<b>305</b>	<b>312</b>	<b>320</b>
90°	617	672	688	705
38°	<b>225</b>	<b>250</b>	<b>257</b>	<b>265</b>
100°	496	551	567	584

### Raffreddamento ad acqua - Water Cooled Unit

Temp. aria Air Temp.	Temp. acqua / Water Temp.			
	32°	21°	15°	10°
°C	32°	21°	15°	10°
°F	90°	70°	60°	50°
10°	<b>315</b>	<b>347</b>	<b>365</b>	<b>370</b>
50°	694	765	805	816
21°	<b>300</b>	<b>332</b>	<b>350</b>	<b>355</b>
70°	661	732	772	783
32°	<b>280</b>	<b>315</b>	<b>327</b>	<b>335</b>
90°	617	694	721	739
38°	<b>270</b>	<b>305</b>	<b>317</b>	<b>325</b>
100°	595	672	699	716

Vista frontale  
Front view

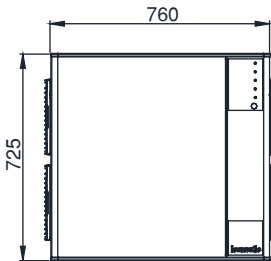

Vista laterale  
Lateral view

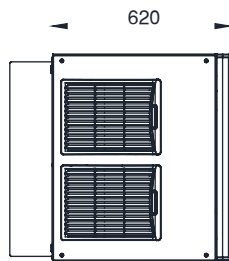

Vista superiore  
Top view

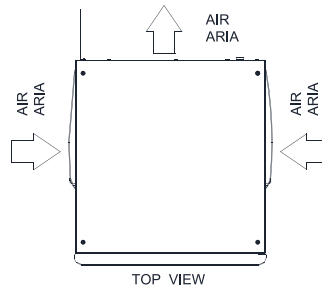

AIR COOLED 

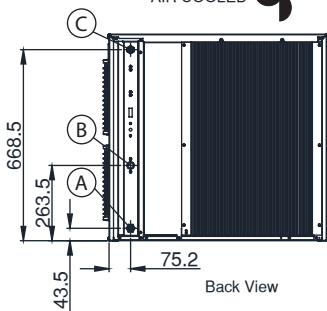

Back View

WATER COOLED 

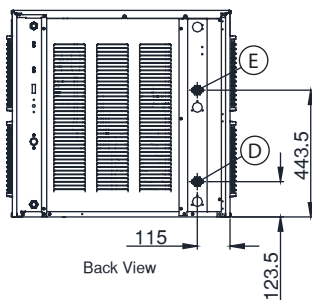



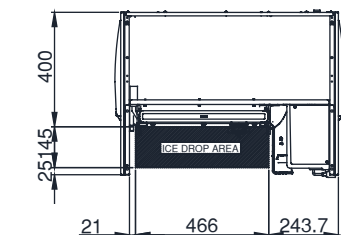



Back View



- A** Water drain Ø20 mm
- B** Potable water inlet 3/4 GAS
- C** Electrical cable supply
- D** Water cooled inlet 3/4 GAS
- E** Water cooled outlet 3/4 GAS



### PANNELLO DI CONTROLLO - CONTROL PANEL

	Alimentazione Powered
	In Funzionamento Operating
	Deposito Pieno/Lavaggio Storage Full / Washing
	Allarme Alarm
	Allarme Alta Pressione High Pressure Alarm
	Pulsante Reset/Lavaggio Button Reset/Washing



### DIMENSIONI - DIMENSIONS

LxPxH(mm): 760 x 620 x 725  
WxDxH(in): 29 15/16" x 24 7/16" x 28 9/16"

### DEPOSITO - SLOPE BIN

D205 - D255 - D305(KM305)  
D405 (KFM404) - D505 (KFM505)

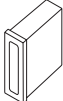
### TIPO GHIACCIO - ICE TYPE

	<b>HALF-LARGE</b> 10 x 29 x 24 - 6 gr <b>555</b> PZ. / CICLO PCS / CYCLE
	<b>DICE</b> 22 x 22 x 24 - 10 gr <b>342</b> PZ. / CICLO PCS / CYCLE
	<b>LARGE</b> 29 x 29 x 24 - 17 gr <b>210</b> PZ. / CICLO PCS / CYCLE

### CONDIZIONI USO-OPERATING REQUIREMENTS



220-240V / 1 / 50HZ R452A GWP=3922

MIN	MAX
10°C (50°F)	40°C (104°F)
5°C (41°F)	35°C (95°F)
- 10 %	+ 10 %
1 BAR (14 PSI)	5 BAR (70 PSI)

Calore espulso - Rejected Heat **4559 W**  
Volume aria - Air Volume **1180 m³/h**

M402 220 - 240 V / 1 / 50Hz - Modular Ice Makers